



TENSIÓN PELIGROSA

Únicamente el personal de mantenimiento eléctrico especializado deberá instalar y prestar servicios de mantenimiento en este equipo. Cortar la alimentación del equipo antes de realizar cualquier trabajo en él.

HAZARDOUS VOLTAGE

This equipment must be installed and serviced only by qualified electrical personnel. Turn off the equipment before maintenance work.

Refs. ACT63SDA/300

Características / Characteristics	Valores / Values
Tipo de red / Network type	230V~ 50Hz
Tipo interruptor diferencial / RCCB type	A
Características técnicas / Technical characteristics	4P 63A/300mA
Interruptor automático / MCB	63A
Características técnicas / Technical characteristics	C 6kA
Prot. contra sobretensiones Clase II / Overvoltage protection Class II	PSTC440T
Corriente de descarga nominal (In) / Nominal discharge current (In)	20 kA
Corriente de descarga máx. (Imax) / Maximum discharge current (Imax)	40 kA
Nivel de protección a In (Up) / Protection level at In (Up)	1.5 kV
DPS protegido/ SPD protected	Fusible/Fuse

Dimensiones / Dimensions (mm)

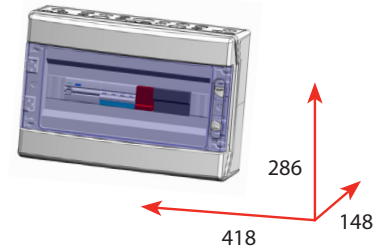

Caja/Base:

Polycarbonato (PC)
Polycarbonate (PC)

Tapa/Cover:

Polycarbonato (PC)
Polycarbonate (PC)



6500 ft max
2000 m max



-40/+185° F max
-40/+80°C max

Diagrama de cableado / Wiring diagram

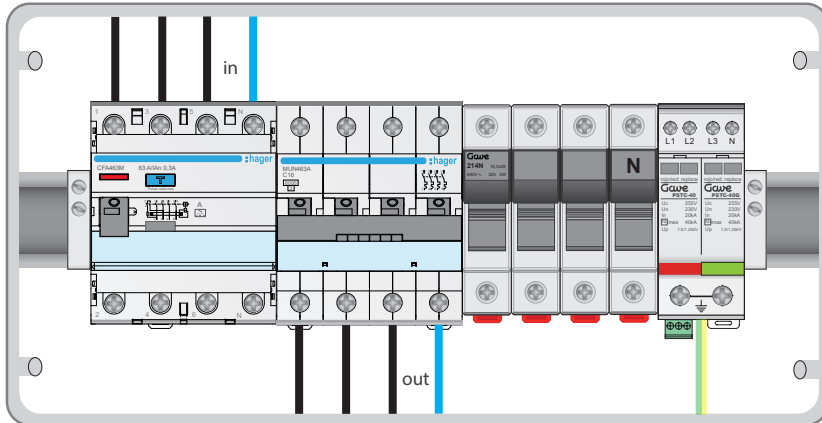

Esquema eléctrico / Electrical scheme

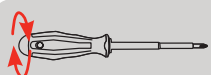
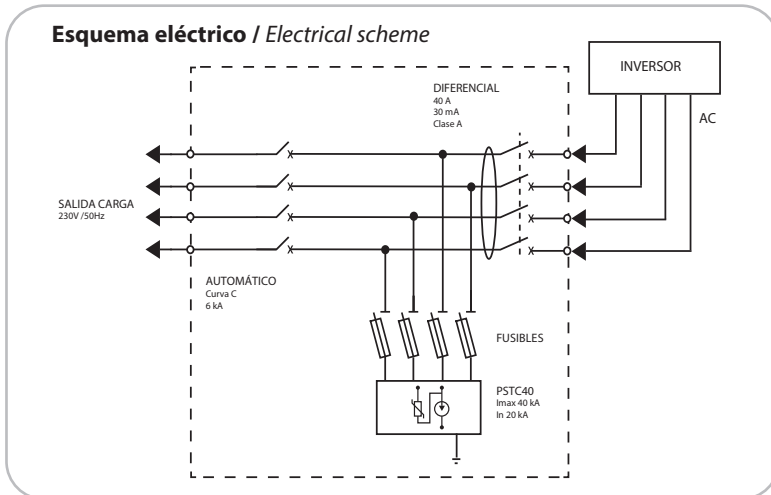

Reapretar todos los tornillos antes de la puesta en marcha.
Tighten all screw connections before the first setup.

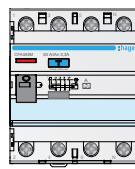

10mm
Min. 1 mm²
Max. 16 mm²
Pz2
2,8 Nm

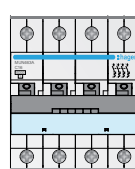

10mm
Min. 1 mm²
Max. 25 mm²
Pz2
2,8 Nm



10mm
Min. 4 mm²
Max. 25 mm²
Pz2
2,5 Nm

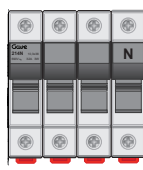

10mm
Min. 4 mm²
Max. 25 mm²
Pz2
2,5 Nm